

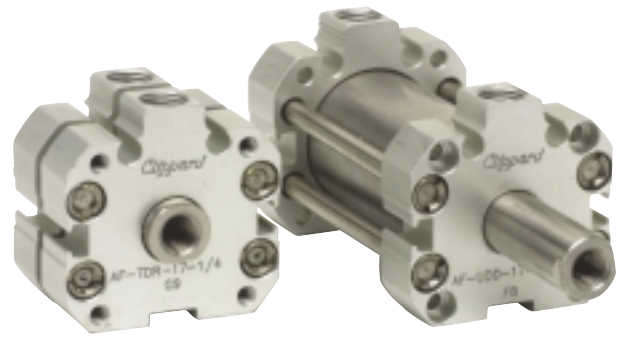

1 1/16" BORE AFO COMPACT CYLINDER

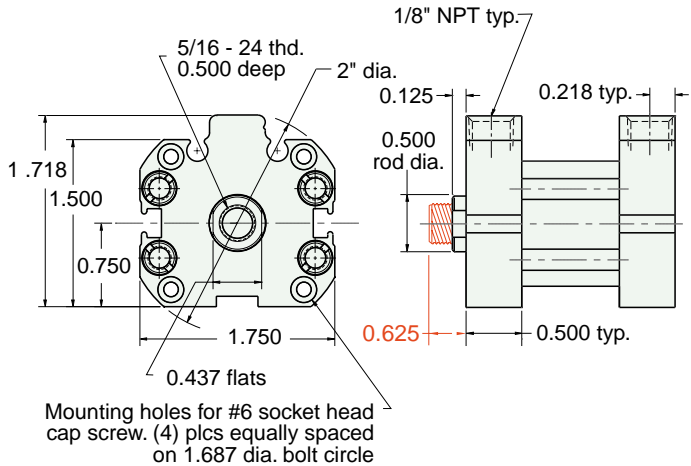

AF - □□□ - 17 - □



For rod with male thread option, add -T to the end of the part number after Stroke
See page 76 for Air Force One numbering system

MOUNTING STYLES

Five mounting styles give you versatility and fast, easy installation.

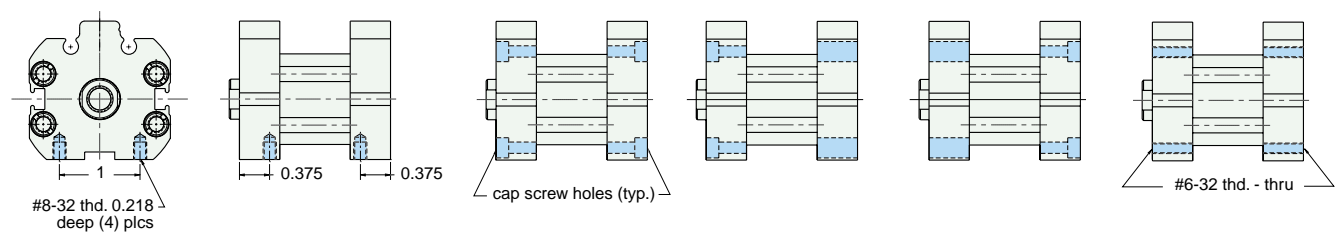

Bottom Mount
AF-Bxx-17-x

Universal Mount
AF-Uxx-17-x

Front Mount
AF-Fxx-17-x

Rear Mount
AF-Rxx-17-x

Thread Mount
AF-Txx-17-x

CYLINDER LENGTHS

"L"	Stroke	Spring Return	Spring Extend
L1	1/4" - 1"	7/8"	
L1	1 1/8" - 2"	1 1/2"	
L1	2 1/8" - 3"	2 1/8"	
L1	3 1/8" - 4"	2 3/4"	
L2	1/4" - 1"		1 3/8"
L2	1 1/8" - 2"		2"
L2	2 1/8" - 3"		2 5/8"
L2	3 1/8" - 4"		3 1/4"

Overall length of body is stroke plus "L"

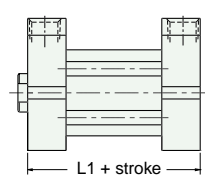

Spring Return
AF-xSR-17-x

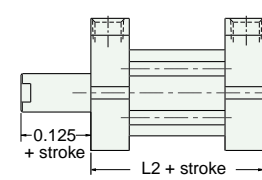

Spring Extend
AF-xRR-17-x

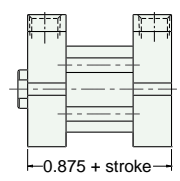

Double Acting
Single Rod
AF-xDR-17-x

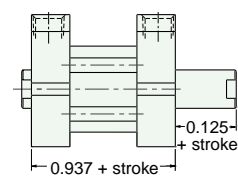

Double Acting
Double Rod
AF-xDD-17-x

Spring Forces	
Spring Return	
Compressed	At Rest
11.500 lbs.	5.500 lbs.
Spring Extend	
Compressed	At Rest
11.500 lbs.	5.500 lbs.